

Inhalt
Contents
Contenu

Inhoud
Contenido
Conteúdo

Contenuto
Содержание
目录

Einzelteilübersicht / Spare parts list / Liste des pièces détachées / Onderdelenoverzicht / Lista da piezas / Resumo de peça individual /
Singoli componenti / Перечень деталей / 零件概览 2

Montagetipps / Tips for assembly / Tuyaux pour le montage / Montagetips / Consejos para el montaje / "Dicas" para montagem /
Consigli per il montaggio / Советы по сборке / 装配建议 3

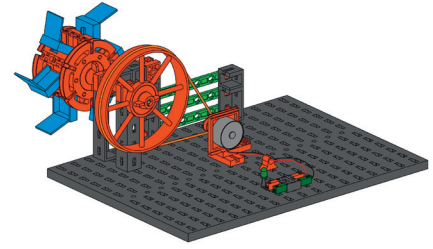
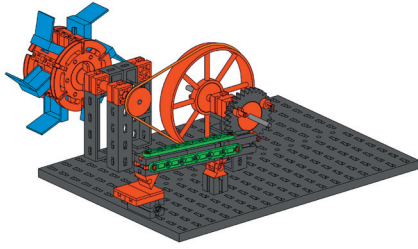

Hammerschmiede / Hammer mill / Forges à marteaux-pilons /
Hamersmederij / Forja de martillo pilón / Forja de martelos / Fucina /
Кузнечный молот / 锤锻 5

Wasserturbine / Water turbine / Turbine hydraulique / Waterturbine /
Turbina de agua / Turbina hidráulica / Turbina idraulica /
Гидротурбина / 水轮机 9

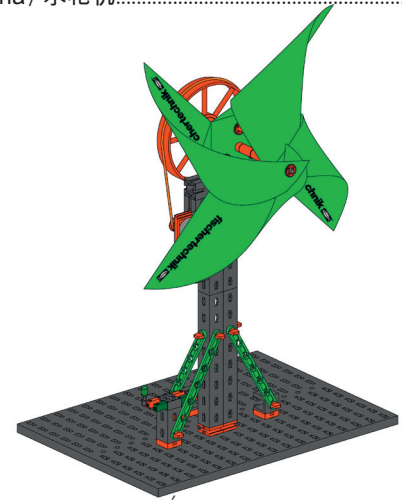
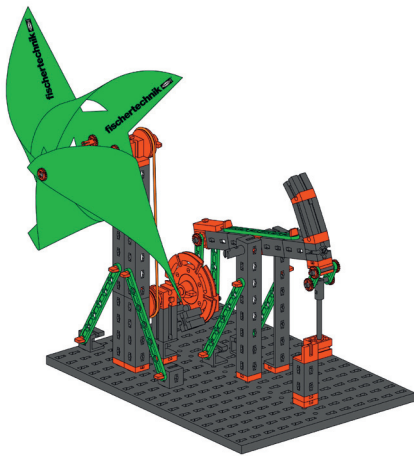

Windrad mit Pumpe / Windmill with pump / Roue éolienne avec pompe /
Wieken met pomp / Rueda de viento con bomba / Turbina eólica com
bomba / Pala eolica con pompa / Ветряное колесо с насосом /
风车和泵 12

Windkraftanlage / Windpower Station / Éolienne / Windkrachtinstallatie /
Instalación eólica / Estación eólica / Impianto eolico / Ветросиловая
установка / 风力发电机 18

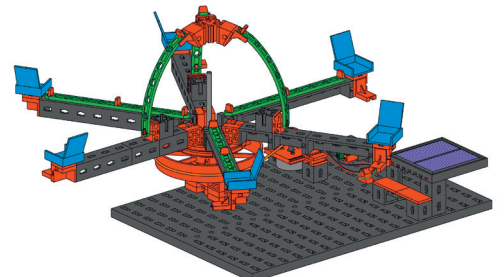
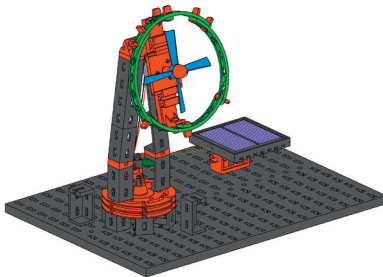

Ventilator / Ventilating fan / Ventilateur / Ventilator / Ventilador / Ventilador /
Ventola / Вентилятор / 风扇 23

Karussell / Merry-go-round / Manège / Draaimolen / Tiovivo / Carrossel /
Giostra / Карусель / 旋转木马 28

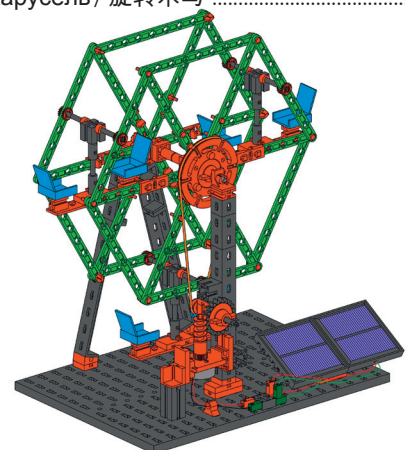
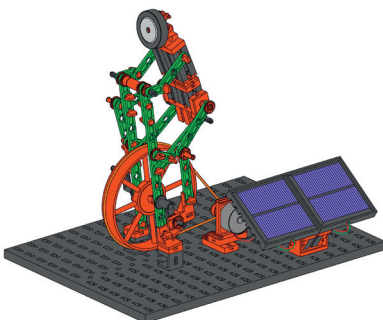

Radfahrer / Bicycle rider / Cycliste / Fietser / Ciclista / Ciclista / Ciclista /
Велосипедист / 骑自行车的人 34

Riesenrad / Ferris wheel / Grande roue / Reuzenrad / Rueda gigante /
Roda gigante / Ruota gigante / Колесо обозрения / 大转轮 38

Inhalt
Contents
Contenu

Inhoud
Contenido
Conteúdo

Contenuto
Содержание
目录

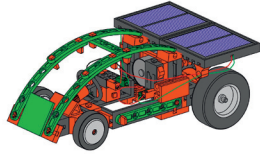

Solarfahrzeug / Solar vehicle / Véhicule solaire / Voertuig op zonne-energie / Vehículo solar / Veículo solar / Veículo ad energia solare / Электромобиль с солнечными батареями / 太阳能电动车.....46

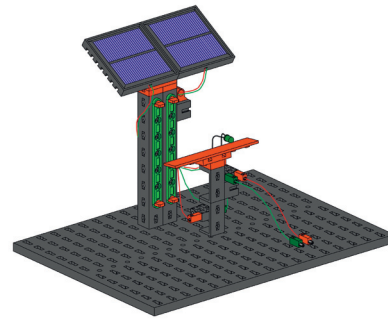

Solartankstelle / Solar charging station / Panneau solaire photovoltaïque / Oplaadstation op zonne-energie / Estación de servicio solar / Posto de abastecimento solar / Pannello solare fotovoltaico / Солнечная зарядная станция / 太阳能充电站.....50

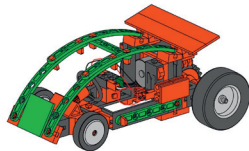

Elektrofahrzeug / Electric vehicle / Véhicule électrique / Elektrisch voertuig / Vehículo eléctrico / Veículo elétrico / Veicolo elettrico / Электромобиль / Электромобиль 电动车.....52

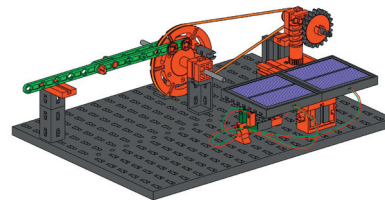

Schranke / Barrier / Barrière / Spoorboom / Barrera / Barreira / Barriera / Шлагбаум / 栏杆.....54

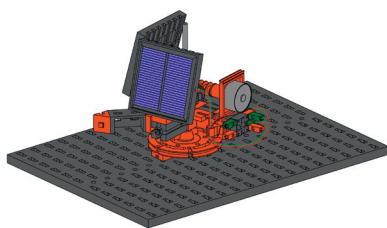

Solarnachführung / Solar tracking / Orientation du panneau solaire / Zonvolgsysteem / Seguimiento solar / Traçamento solar / Orientamento pannelli solari / Слежение за солнцем / 太阳跟踪仪.....58

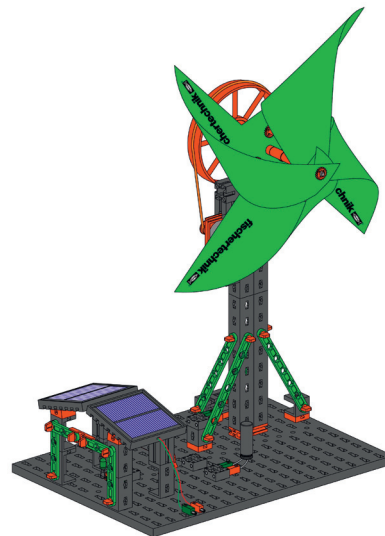

Ökohaus / Eco-house / Maison écologique / Ecologisch huis / Casa ecológica / Casa ecológica / Eco casa / Эко-дом / 生态房屋.....61

Sortiervorschlag für Aufbewahrungssystem / Storage suggestion for storage system / Suggestion de classement pour le système de stockage / Sorteervoorstel voor bewaarsysteem / Propuesta de clasificación para almacenamiento / Proposta de divisão caixa 1 para sistema de conservação / Proposta di sistemazione per il sistema di conservazione / Рекомендации по сортировке для системы хранения / 保存系统的分类建议

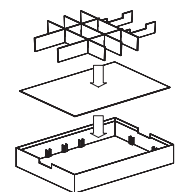













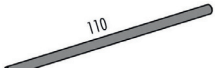
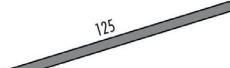



















Profi Oeco Energy + Fuel Cell Kit77











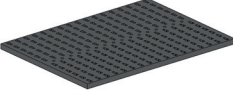





Einzelteilübersicht
Spare parts list
Liste des pièces détachées













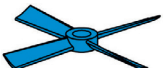

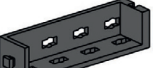
Onderdelenoverzicht
Lista da piezas
Resumo de peça individual

Singoli componenti
Перечень деталей
零件概览

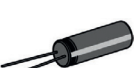
	19 317 1 x
	31 010 2 x
	31 011 3 x
	31 019 2 x
	31 021 1 x
	31 031 1 x
	31 036 1 x
	31 058 5 x
	31 124 2 x
	31 336 11 x
	31 337 9 x
	31 426 1 x
	31 436 3 x
	31 597 8 x
	31 667 4 x
	31 671 2 x
	31 674 3 x

	31 690 3 x
	31 848 6 x
	31 915 2 x
	31 916 1 x
	31 981 4 x
	31 982 32 x
	31 983 3 x
	32 064 6 x
	32 071 4 x
	32 228 2 x
	32 229 1 x
	32 230 1 x
	32 850 3 x
	32 870 1 x
	32 879 2 x
	32 881 4 x
	32 913 2 x

	32 985 1 x
	34 995 2 x
	35 031 5 x
	35 033 1 x
	35 049 6 x
	35 051 6 x
	35 063 3 x
	35 064 1 x
	35 065 3 x
	35 069 1 x
	35 088 2 x
	35 405 3 x
	35 969 2 x
	35 980 2 x
	36 227 6 x
	36 264 1 x
	36 293 4 x

	36 323 24 x
	36 324 12 x
	36 334 15 x
	36 337 1 x
	36 443 1 x
	36 920 6 x
	36 921 2 x
	36 922 4 x
	36 950 2 x
	36 973 1 x
	37 031 1 x
	37 237 10 x
	37 468 12 x
	37 679 8 x
	37 681 1 x
	37 783 1 x
	37 858 1 x

Einzelteilübersicht
Spare parts list
Liste des pièces détachées

	38 216 4 x
	38 240 6 x
	38 241 2 x
	38 245 3 x
	38 413 3 x
	38 423 6 x
	38 428 6 x

Onderdelenoverzicht
Lista da piezas
Resumo de peça individual

	68 451 1 x
	69 205 1 x
	116 913 2 x
	136 775 1 x
	137 103 1 x
	137 357 1 x

	143 235 4 x
	143 236 14 x
	146 142 2 x
	146 529 4 x
	146 531 4 x
	146 532 4 x
	146 533 12 x

Singoli componenti
Перечень деталей
零件概览

	146 534 1 x
	146 535 2 x
	35 608 1 x
	147 009 1 x

Montagetipps
Tips for assembly
Tuyaux pour le montage

Montagetips
Consejos para el montaje
"Dicas" para montagem

Consigli per il montaggio
Советы по сборке
装配建议

Kabel und Stecker / Plugs and cables / Fiches et des câbles
 Steckers en cables / Enchufes en cables / Cabos e contatos
 Cavi e connettori / Провода и штекеры / 电缆和插头

1

2

max 2,3 V ...

Langer Draht + = roter Stecker
 Long wire + = red plug
 Fil long + = fiche rouge
 Lange draad + = rode stecker
 Alambre largo + = conector rojo
 Fio longo + = conector vermelho
 Filo lungo + = connettore rosso
 Длинный провод + = красный штекер
 长电线 + = 红色插头

Kurzer Draht - = grüner Stecker
 Short wire - = green plug
 Fil court - = fiche verte
 Korte draad - = groene stecker
 Alambre corto - = conector verde
 Fio curto - = conector verde
 Filo corto - = connettore verde
 Короткий провод - = зеленый штекер
 短电线 - = 绿色插头

25 cm
20 cm
15 cm
10 cm
5 cm
0