

Inhalt
Contents
Contenu

Inhoud
Contenido
Conteúdo

Contenuto
Содержание
目录

Einzelteilübersicht / Spare parts list / Liste des pièces détachées / Onderdelenoverzicht / Lista da piezas / Resumo de peça individual / Singoli componenti / Перечень деталей / 零件概览 1

Montagetipps / Tips for assembly / Tuyaux pour le montage / Montagetips / Consejos para el montaje / "Dicas" para montagem / Consigli per il montaggio / Советы по сборке / 装配建议 2

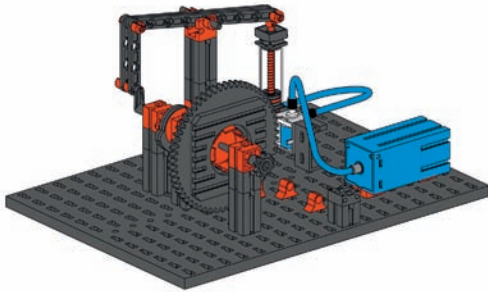

Druckluftmotor / Compressed air motor / Moteur pneumatique / Persluchtmotor / Motor de aire comprimido / Motor de ar comprimido / Motore ad aria compressa / пневмомотор / 压缩空气马达 5

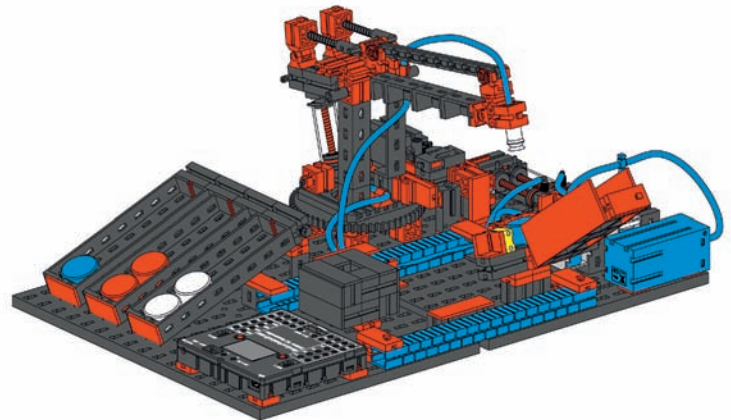

Farbsortierroboter / Color sorting robot / Robot de triage des couleurs / Kleurensorteerrobot / Robot clasificador por colores / Robo seleccionador de cores / Robot assortitore di colori / Робот-цветосортировщик / 辨色分选机器人 9

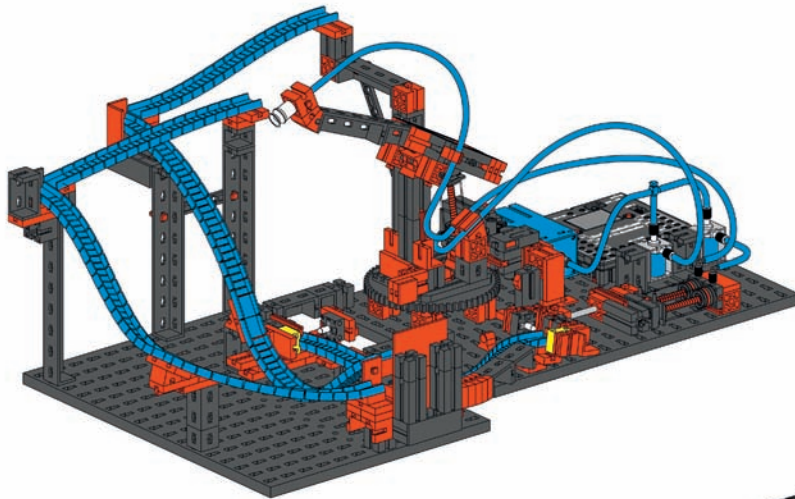

Kugelparcours mit Vakuumgreifer / Ball obstacle course with vacuum picker arm / Parcours à billes avec grappin pneumatique / Kogelparcour met vacuümgreijper / Pista de recorrido de bola con manipulador de vacío / Circuito de esferas com agarrador a vácuo / Percorso sfero con pinza a ventosa / Трасса для шарика с вакуумным захватом / 配分选机器人的滚珠弯道 21

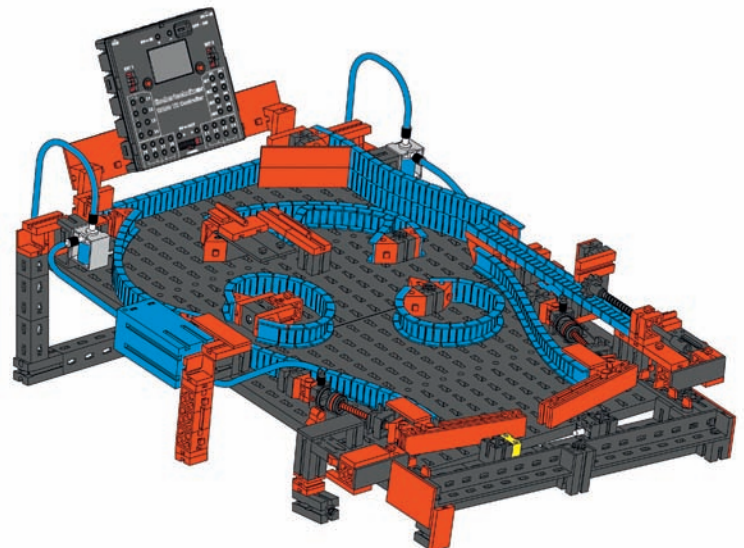















Flipper / Pinball machine / Flipper / Flipper / Pinball / Flipper / Flipper / пинбол-машина / 弹球机 33

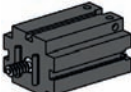

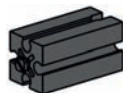
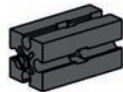

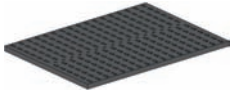











Einzelteilübersicht
Spare parts list
Liste des pièces détachées

















Onderdelenoverzicht
Lista da piezas
Resumo de peça individual

Singoli componenti
Перечень деталей
零件概览

	31 010 10 x
	31 011 4 x
	31 040 1 x
	31 058 2 x
	31 060 5 x
	31 061 5 x
	31 078 1 x
	31 082 1 x
	31 330 2 x
	31 336 19 x
	31 337 20 x
	31 390 1 x
	31 391 1 x
	31 422 1 x
	31 426 6 x
	31 436 6 x
	31 597 2 x

	31 642 2 x
	31 690 2 x
	31 981 4 x
	31 982 25 x
	32 064 17 x
	32 071 13 x
	32 293 1 x
	32 330 5 x
	32 850 7 x
	32 879 10 x
	32 880 2 x
	32 881 24 x
	32 882 6 x
	32 985 2 x
	35 031 2 x
	35 049 23 x
	35 063 1 x

	35 065 5 x
	35 066 1 x
	35 073 2 x
	35 088 1 x
	35 327 2 x
	35 328 5 x
	35 945 2 x
	35 969 3 x
	36 134 2 x
	36 227 2 x
	36 293 6 x
	36 323 8 x
	36 334 2 x
	36 443 1 x
	36 532 1 x
	36 911 2 x
	36 913 2 x

	36 915 3 x
	36 920 11 x
	36 921 2 x
	36 922 3 x
	36 950 4 x
	36 952 1 x
	37 034 1 x
	37 157 1 x
	37 237 28 x
	37 238 3 x
	37 468 18 x
	37 636 2 x
	37 679 6 x
	37 727 2 x
	37 783 2 x
	37 875 2 x
	38 216 2 x

Einzelteilübersicht
Spare parts list
Liste des pièces détachées

	38 240 7 x
	38 241 7 x
	38 242 3 x
	38 245 2 x
	38 246 3 x
	38 248 2 x
	38 251 2 x

Onderdelenoverzicht
Lista da piezas
Resumo de peça individual

	38 261 6 x
	38 414 1 x
	38 423 3 x
	38 428 3 x
	38 464 2 x
	38 546 2 x
	121 470 1 x

	121 640 1 x
	121 641 11 x
	122 363 1 x
	122 409 1 x
	128 599 1 x
	132 875 2 x
	133 027 3 x

Singoli componenti
Перечень деталей
零件概览

	133 028 1 x
	133 200 2 x
	133 201 2 x
	133 202 2 x
	144 262 2 x

Montagetipps
Tips for assembly
Tuyaux pour le montage

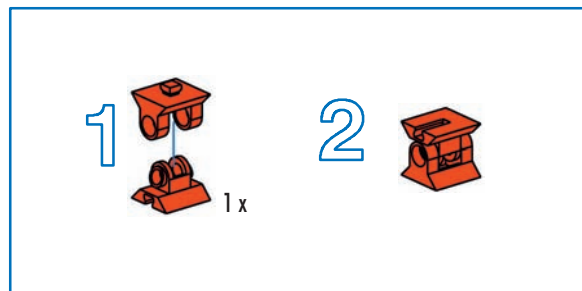

Montagetipps
Consejos para el montaje
"Dicas" para montagem

Consigli per il montaggio
Советы по сборке
装配建议

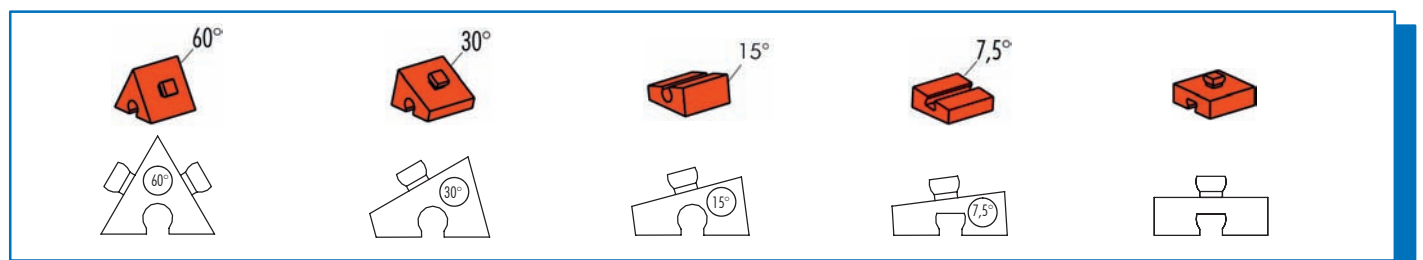
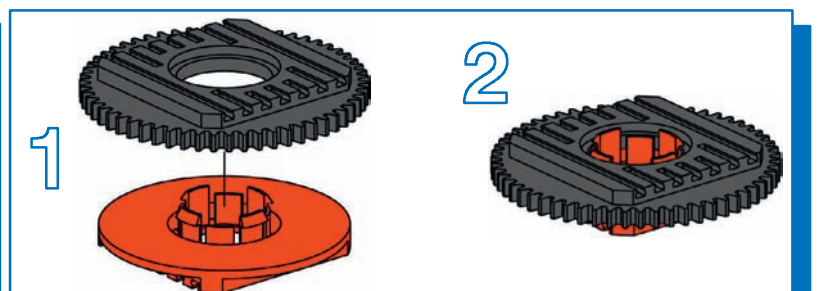

Erfinder Flexprofil Art.-Nr. 121 641:
 Design und Konzeption Andreas Lehrberger

